



GBCA Frostbite Regatta

Galveston Bay

February 26-27, 2011

1500 Marina Bay Dr. Suite 1592, Building #59B, Clear Lake Shores, TX 77565

Sailing Instructions

1. Rules

The regatta will be governed by the *rules* as defined in the current 2009-2012 *Racing Rules of Sailing*, The Notice of Race, and these Sailing Instructions.

2. Notices to Competitors

Notices to competitors will be posted on the door of the GBCA office and at <http://www.regattanetwork.com/clubs/gbca.html>

3. Changes to Sailing Instructions

Any change to the sailing instructions or notice of race will be posted before 0800 on the day it will take effect, except that any change to the schedule of races will be posted by 2000 on the day before it will take effect.

4. Race Schedule

- 4.1 The warning gun for the first race each day will be no earlier than 1100. Subsequent races for each class will follow as soon as possible after the end of the previous race.
- 4.2 The class starting order for the *first* race for each day and the class flags are shown in Appendix A.

5. Racing Area

The racing area will be between Seabrook Channel Marker No. 2 and the Houston Ship Channel, and between San Leon and Morgan's Point. Boats shall not enter the Houston Ship Channel. The Houston Ship Channel is designated as an obstruction.

6. Courses and Marks

a. Windward/Leeward Courses

Marks will be orange and yellow tetrahedrons. The original course marks will be yellow. Change of course marks will alternate between orange and yellow.

Courses will be signaled by a numeral pennant correlating with the course diagrams below. The approximated heading and distance to the windward mark may be displayed on a board on the committee boat

C

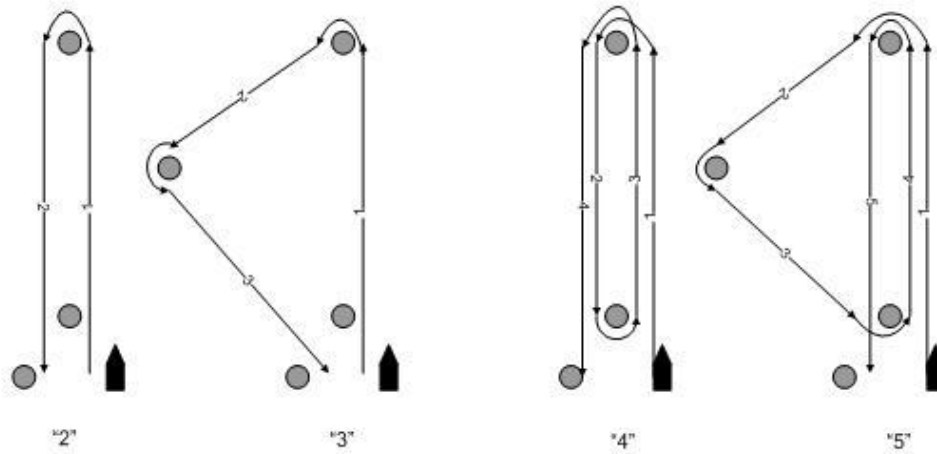

The leeward mark will be set approximately 0.1 nm on the course side of the starting line.

Boats shall leave all turning marks to port.

b. Fixed Mark Courses

Fixed mark courses will be signaled by numerical pennants (see course description in Appendix B). Fixed mark courses will use marks "E", "H", "J" and/or "L". Approximate coordinates and description of the marks are:

Mark	Approximate Coordinate	Description
E	N 29 35.787 W 94.56.935	<i>The Low Range Marker (Upper Range "A") in Galveston Bay. The mark is an orange and white structure near Houston Ship Channel Marker #73, 0.23 nm NNW of the old low range.</i>
H	N 29 33.255' W 94.56.542'	<i>A platform located in Galveston bay, approximately 1.3 nm WSW of the Houston Ship Channel marker #65.</i>
J	N 29 31.353' W 94.54.424'	<i>A platform located approximately 1.0 nm west of the north end of Red Fish Island.</i>
L	N 29 37.13' W 94 57.50'	<i>The old low range mark of the Galveston Bay Upper Range B, located near Houston Ship Channel marker #78.</i>

7. Check In

Before the warning signal of the first race, each boat shall sail past the stern of the Race Committee boat on starboard tack and hail the boat's name or sail number until acknowledged by the Race Committee.

8. The Start

8.1 The starting line will be between the staff displaying an orange flag on the Race Committee boat on the starboard end and the course side edge of the port-end starting mark. The Race

Committee may trail a float and line astern of the Race Committee boat which shall be considered as part of the starting mark.

- 8.2 Boats whose preparatory signal has not been made shall keep clear of the starting area and of all boats whose preparatory signal has been made.
- 8.3 A boat shall not start later than 10 minutes after her starting signal. A boat starting later than 10 minutes after her starting signal shall be scored Did Not Start. This changes RRS A4.
- 8.4 Any class subjected to a General Recall may start after the last scheduled start for that race. This modifies RRS 29.2.

9. Change of the Next Leg of the Course

If the Race Committee displays the "C" code flag with one or more class flags, the course change applies only to those classes. If the "C" code flag is flown alone, all classes will sail the changed course. This modifies RRS 33.

10. Shorten Course

If the Race Committee displays the "S" code flag with one or more class flags, the shortened course applies only to those classes. If the "S" code flag is flown alone, all classes will sail the shortened course. This modifies RRS 32.

11. The Finish

The finish line will be between a staff displaying an orange flag on a Race Committee boat and a nearby mark.

12. Time Limit

The time limit for classes not using fixed marks shall be ninety minutes or thirty minutes after the first boat properly sails the course and finishes, whichever is earlier.

The time limit for classes using fixed marks shall be four hours.

Boats exceeding the time limit will be scored Did Not Finish. This modifies RRS 35.

13. Safety

- 13.1 A boat that retires from a race prior to finishing shall notify the Race Committee, by any means, as soon as practicable on VHF channel 68. If radio communication is unavailable, call the Race Committee phone number: 281-450-1749 and leave a message.
- 13.2 Attention is called to RRS 4: Decision to Race, "The responsibility for a boat's decision to participate in a race or to continue *racing* is hers alone."

14. Protests

- 14.1 Protests shall be written on forms available at the GBCA office and delivered to that office within 2 hours after the last boat finishes the last race.
- 14.2 Finishing boats intending to file a protest shall notify, and be acknowledged by, the Race Committee prior to leaving the finish area.

15. Scoring

The Low Point system, RRS Appendix A will apply. One race constitutes a series. There will be no throw-outs. This modifies RRS A2

16. Sail Numbers

Boats shall carry USSA, class, or hull numbers on mainsails, spinnakers, and each overlapping headsail having a luff perpendicular exceeding 130% of the base of the fore triangle. These sail numbers shall correspond to the sail numbers listed on the scratch sheet, unless different numbers are approved by the Race Committee. Notification of such approval will be posted on <http://www.regattanetwork.com./clubs/gbca.html> before 0800 on the day approval is given.

17. Communication

- 17.1 Radio communication will be conducted on VHF channel 68.
- 17.2 The Race Committee will attempt to monitor and may make courtesy announcements on VHF channel 68. The failure of the Race Committee to make announcements or the manner in which announcements are made will not be grounds for redress. This modifies RRS 62.1(a).
- 17.3 In addition to signaling Individual Recalls in accordance with RRS 29.1, as a courtesy, the Race Committee will attempt to broadcast the names or sail numbers of boats that have started early. Failure to make such a broadcast, failure of a boat to receive that broadcast, a boat's order in that broadcast, or the promptness of that broadcast will not be grounds for redress. This modifies RRS 62.1(a).
- 17.4 If a weather-related postponement is required it will be announced at 1000 on VHF Channel 68.

Appendix A

2011 Frostbite Regatta Starting Order / Class Flags

First Race of Each Day of Racing







J/105 – J/105 Class Flag

PHRF Spin – Purple

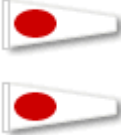
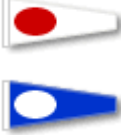
PHRF Non Spin – Pink

GBCA Club Handicap - Green

Appendix B

Course Signal Pennant	Course #	Description	Round Marks To:
	11	Start → H → Finish	Port
	12	Start → E → Finish	Port
	13	Start → J → Finish	Port
	14	Start → L → Finish	Port
	15	Start → H → E → Finish	Port
	16	Start → E → H → Finish	Starboard
	17	Start → E → J → Finish	Starboard
	18	Start → J → E → Finish	Port